



INFORMAZIONI TECNICHE
TECHNICAL INFORMATION
INFORMATIONS TECHNIQUES
INFORMACIONES TECNICAS
TECHNISCHE INFORMATIONEN

PART #
15606U LV-14 R
15606BU LV-14 R BLACK EDITION

FULL SYSTEM

SUZUKI
GSX-8S - GSX-8R

LeoVince



Nome/Given name/Prénom/Vorname/Nombre

.....

Cognome/Surname/Nom/Name/Apellido

.....

Indirizzo/Address/Adresse/Adresse/Dirección

.....

Targa veicolo/Vehicle registration plate/Plaque d'immatriculation/Kennzeichen des Fahrzeuges/Matrícula del vehículo

.....

Tel.

.....

Data e timbro del rivenditore

Date and seller's stamp

Date et tampon du revendeur

Datum und Stempel des Verkäufers

Fecha y sello del vendedor

INDICE - INDEX - INHALTSVERZEICHNIS - INDICE

APPLICAZIONI - FITMENT LIST - AFFECTATIONS APLICACIONES - VERWENDUNGSLISTE	4
LISTA DEI COMPONENTI - LIST OF COMPONENTS LISTE DES COMPOSANTS - VERPACKUNGSINHALT - LISTA DE COMPONENTES	5
PESO - WEIGHT - POIDS - GEWICHT	6
MANUALE DI ISTRUZIONI DIGITALE - DIGITAL OWNER'S MANUAL MANUEL D'INSTRUCTION NUMÉRIQUE - DIGITALE BETRIEBSANLEITUNG MANUAL DE INSTRUCCIONES DIGITAL	6
DISEGNO TECNICO - TECHNICAL DRAWING - DESSIN TECHNIQUE TECHNISCHE ZEICHNUNG - DISEÑO TÉCNICO	7
ISTRUZIONI DI MONTAGGIO	29
FITTING INSTRUCTION	31
NOTICE DE MONTAGE	33
INSTRUCCIONES DE MONTAJE	35
MONTAGEANLEITUNGEN	37

APPLICAZIONI - FITMENT LIST - AFFECTATIONS

APLICACIONES - VERWENDUNGSLISTE

SUZUKI GSX-8R

TYPES WEM2; 1/1, 1/2 - WEM3; 1/1, 1/2

HOMOLOGATION NOT APPROVED

NOTES

- ALSO FITS 35KW VERSION

SUZUKI GSX-8S

TYPES WEM2; 1/1, 1/2 - WEM3; 1/1, 1/2

HOMOLOGATION NOT APPROVED

NOTES

- ALSO FITS 35KW VERSION
- COMPATIBLE WITH ORIGINAL UNDER COWL PART # 94400-25810-000
- WARNING! NOT COMPATIBLE WITH ORIGINAL UNDER COWL PART # 99F00-SAB8S-QU1

LISTA DEI COMPONENTI - LIST OF COMPONENTS - LISTE DES COMPOSANTS - VERPACKUNGSINHALT - LISTA DE COMPONENTES

PART #: 15606U LV-14 R

COMPONENTE - COMPONENT - COMPOSANT - KOMPONENT - COMPONENTE	P/N
Collettore - Linkpipe - Tube de raccord - Verbindungsrohr - Tubo de conexión	3014442211
Carter paracalore - Heat shield - Cache pare-chaleur - Hitzeschild - Protector de calor	3015401001
Collettore - Linkpipe - Tube de raccord - Verbindungsrohr - Tubo de conexión	3015606202
Collettore - Linkpipe - Tube de raccord - Verbindungsrohr - Tubo de conexión	3015606204
Staffa - Bracket - Patte - Halter - Soporte	3015606561
Staffa - Bracket - Patte - Halter - Soporte	3015606562
Kit minuteria - Fitting kit - Kit de fixation - Montagesatz - Kit de montaje	3015606601
Silenziatore - Muffler - Silencieux - Endschalldämpfer - Silenciador	3015606481U

PART #: 15606BU LV-14 R BLACK EDITION

COMPONENTE - COMPONENT - COMPOSANT - KOMPONENT - COMPONENTE	P/N
Collettore - Linkpipe - Tube de raccord - Verbindungsrohr - Tubo de conexión	3014442211
Carter paracalore - Heat shield - Cache pare-chaleur - Hitzeschild - Protector de calor	3015401001
Collettore - Linkpipe - Tube de raccord - Verbindungsrohr - Tubo de conexión	3015606202
Collettore - Linkpipe - Tube de raccord - Verbindungsrohr - Tubo de conexión	3015606204
Staffa - Bracket - Patte - Halter - Soporte	3015606561
Staffa - Bracket - Patte - Halter - Soporte	3015606562
Kit minuteria - Fitting kit - Kit de fixation - Montagesatz - Kit de montaje	3015606601
Silenziatore - Muffler - Silencieux - Endschalldämpfer - Silenciador	3015606485U

PESO - WEIGHT - POIDS - GEWICHT

Originale / Stock / Origine / Original	7.78 Kg
15606U - LV-14 R	5.05 Kg
15606BU - LV-14 R BLACK EDITION	5.05 Kg

MANUALE DI ISTRUZIONI - OWNER'S MANUAL - MANUEL D'INSTRUCTION MANUAL DE INSTRUCCIONES - BETRIEBSANLEITUNG

Scansiona il codice QR per scaricare l'ultima versione del manuale di istruzioni.

Scan the QR code to download the latest version of the owner's manual.

Scannez le code QR pour télécharger la dernière version du manuel d'instructions.

Escanee el código QR para descargar la última versión del manual de instrucciones.

Scannen Sie den QR-Code, um die neueste Version der Bedienungsanleitung herunterzuladen.



https://static.leovince.com/products/booklets/15606U-15606BU_booklet_web.pdf

R I D E . D O M I N A T E . R O A R .



dB-Killer Ø38 n° 80
P/N 3015602801

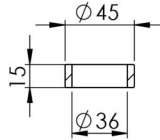

S.S. Bushing
P/N 207133

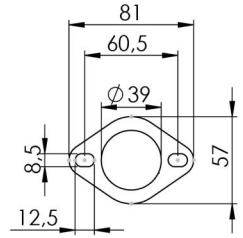

S.S. Flange 25B
P/N 200560

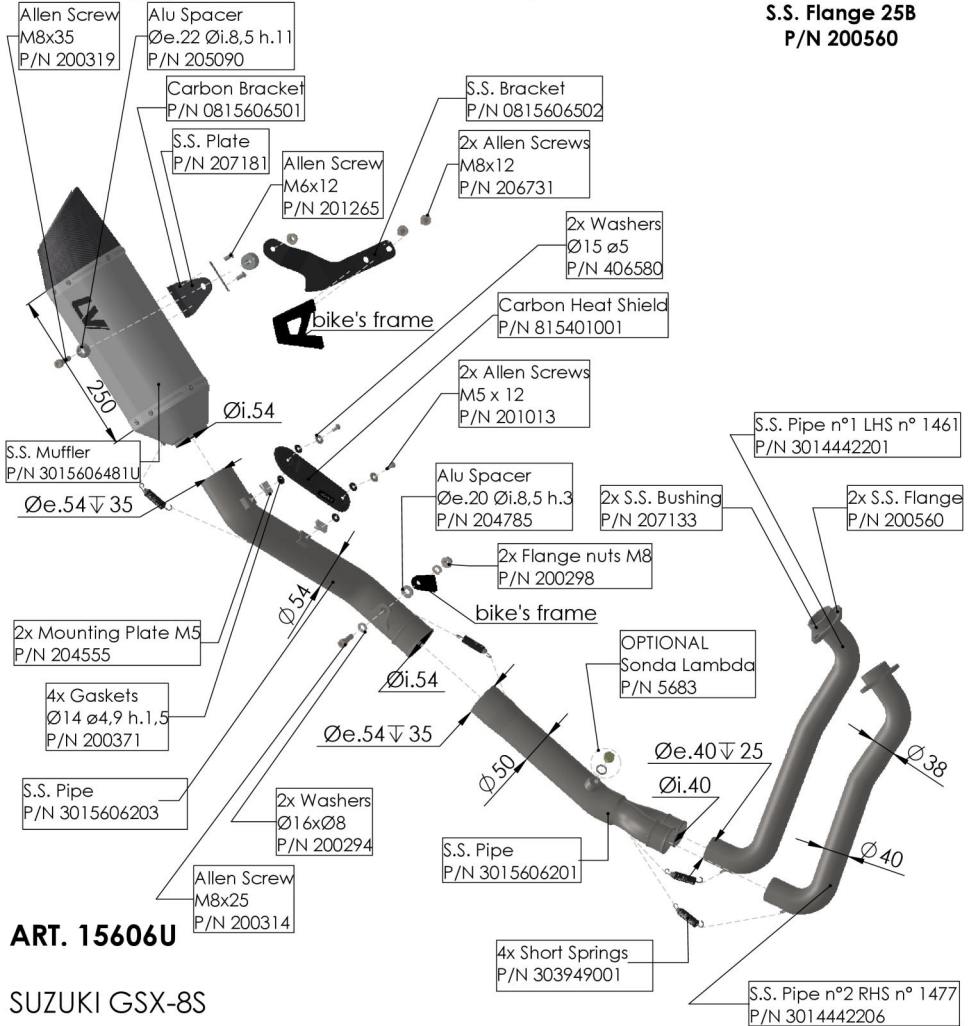

ART. 15606U

SUZUKI GSX-8S

FULL SYSTEM LV-14 R STAINLESS STEEL

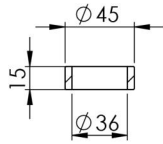

S.S. Bushing
P/N 207133

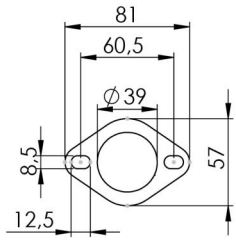

S.S. Flange 25B
P/N 200560

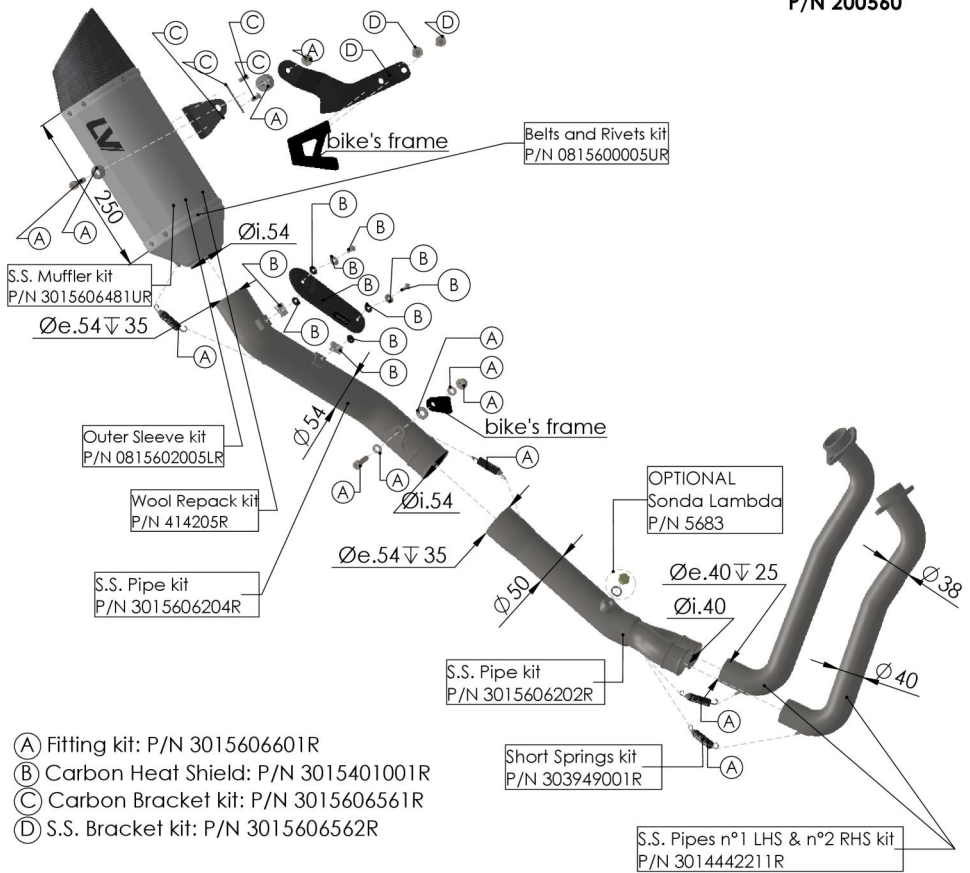

ART. 15606U - SPARE PARTS

SUZUKI GSX-8S

FULL SYSTEM LV-14 R STAINLESS STEEL

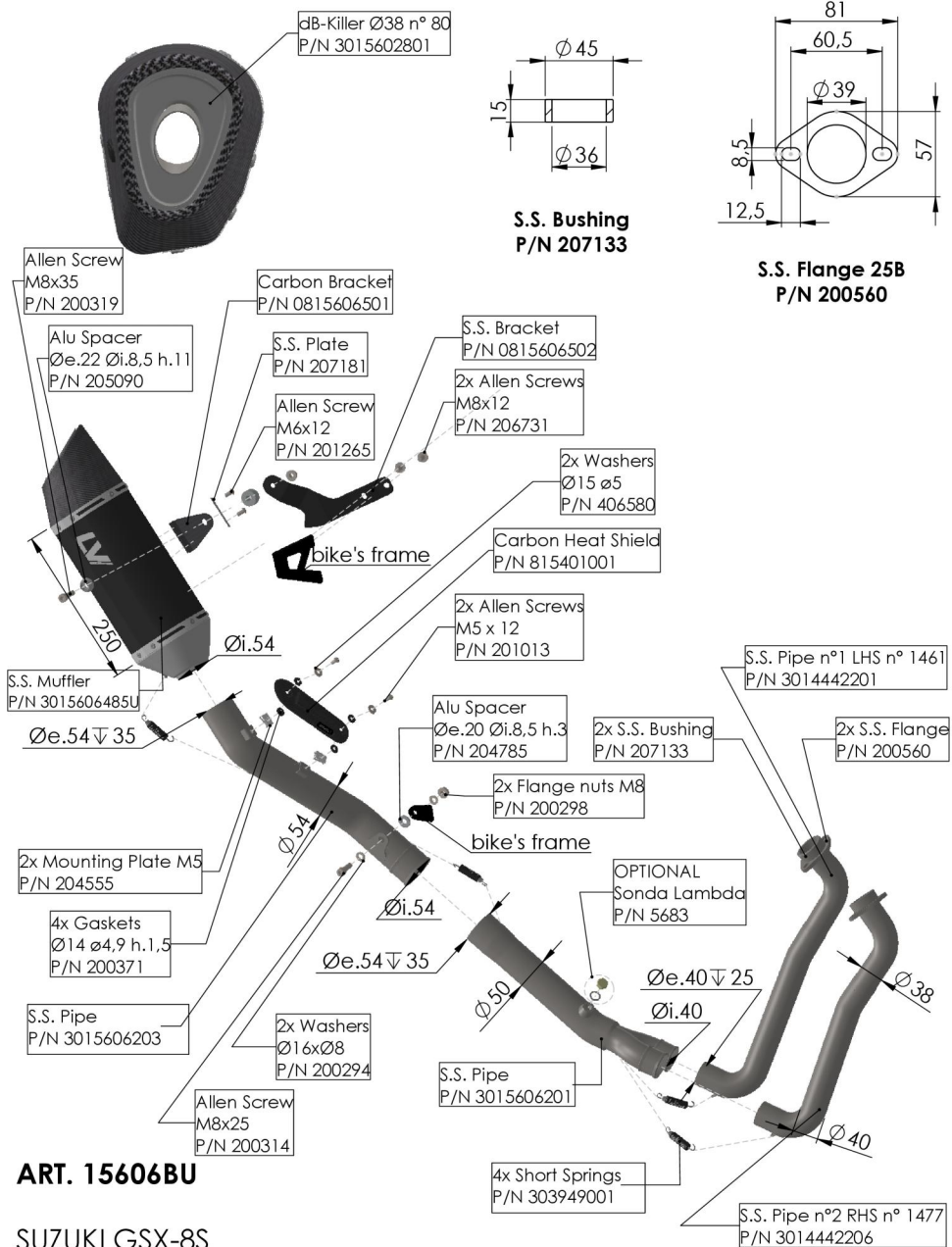

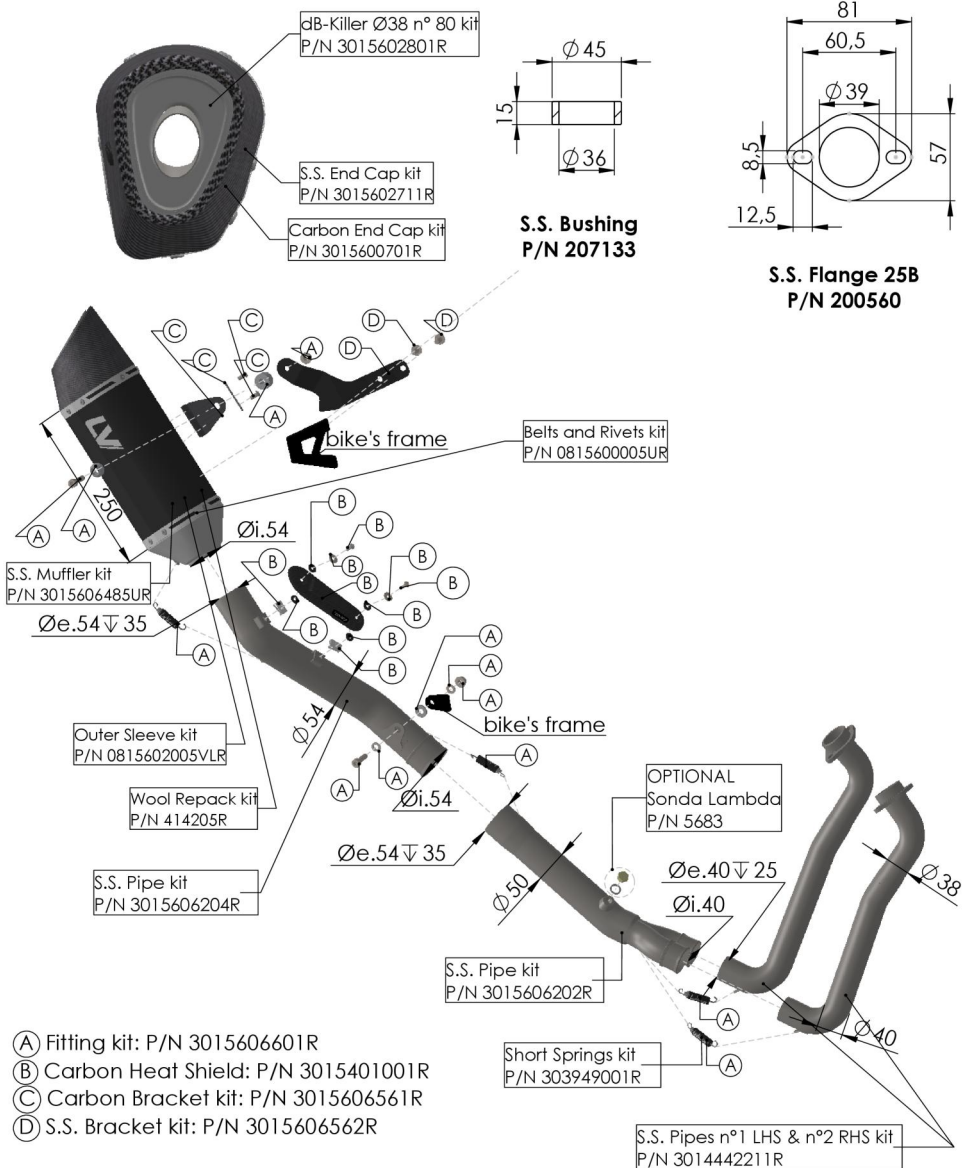

- (A) Fitting kit: P/N 3015606601R
- (B) Carbon Heat Shield: P/N 3015401001R
- (C) Carbon Bracket kit: P/N 3015606561R
- (D) S.S. Bracket kit: P/N 3015606562R

ART. 15606BU - SPARE PARTS

SUZUKI GSX-8S

FULL SYSTEM LV-14 R BLACK EDITION

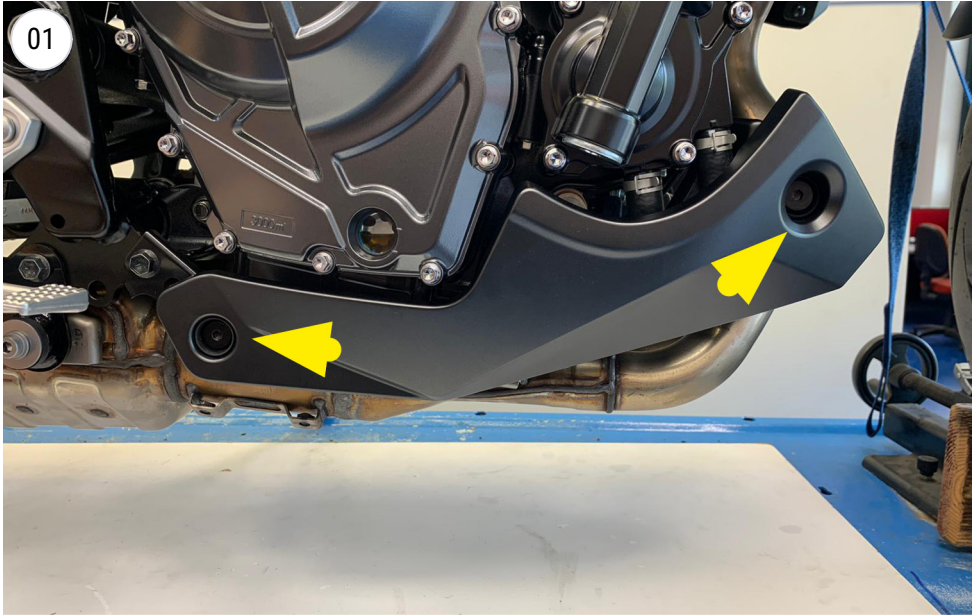

UNSCREW - IF YOU DO NOT HAVE THE UNDER COWL GO TO PHOTO 14



UNSCREW - ONLY IF YOU HAVE SUZUKI GSX-8R OTHERWISE GO TO PHOTO 14

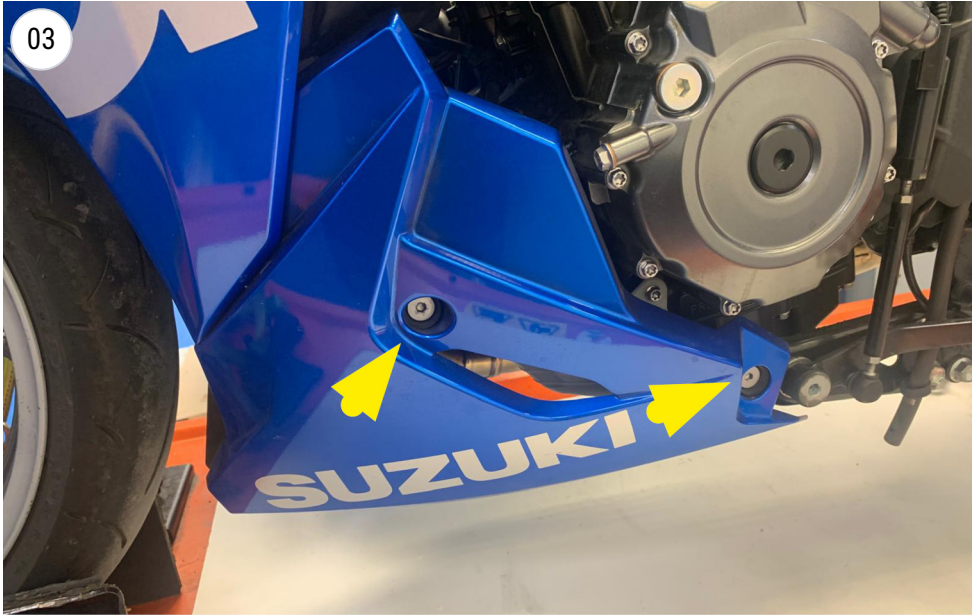

UNSCREW

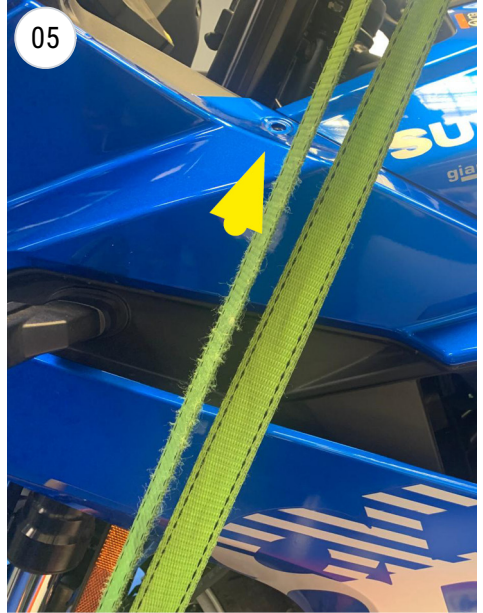

UNSCREW

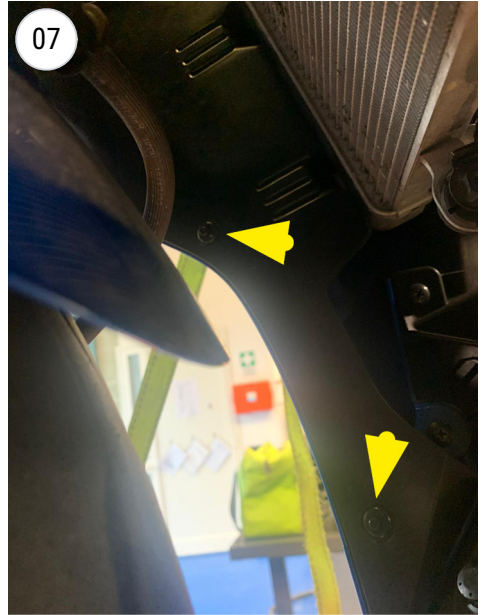

REMOVE THE PLASTIC FASTENERS



REMOVE THE PLASTIC FASTENERS



REMOVE THE FAIRINGS



REMOVE THE FAIRINGS



REMOVE THE CONNECTOR



UNSCREW AND REMOVE THE LAMBDA/OXYGEN SENSOR

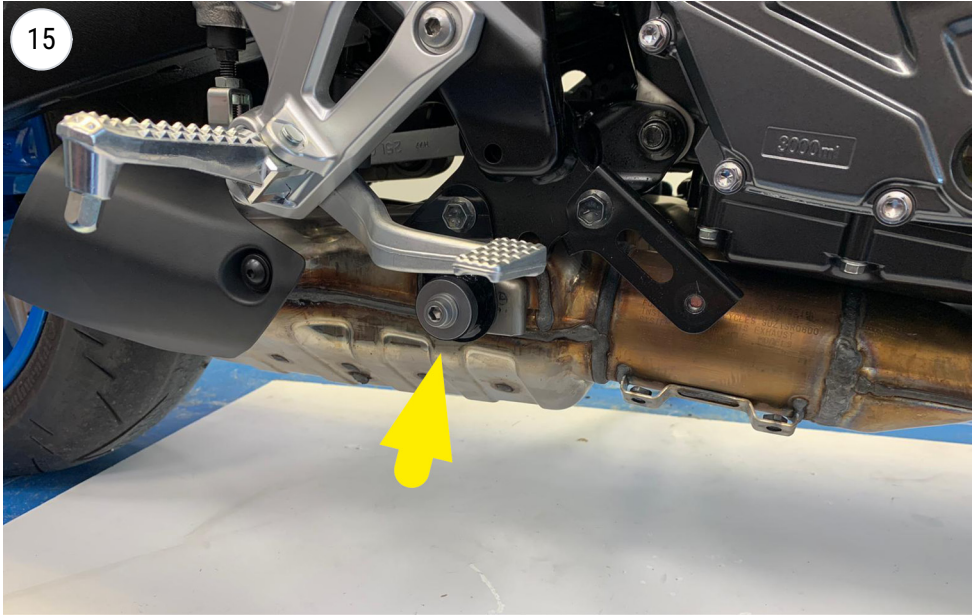

UNSCREW



UNSCREW

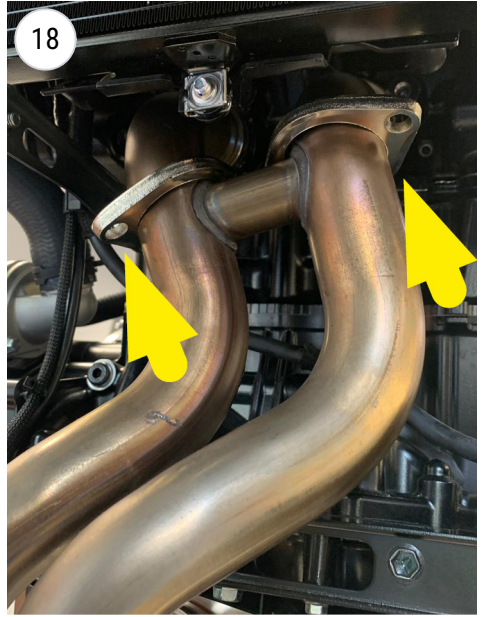

UNSCREW

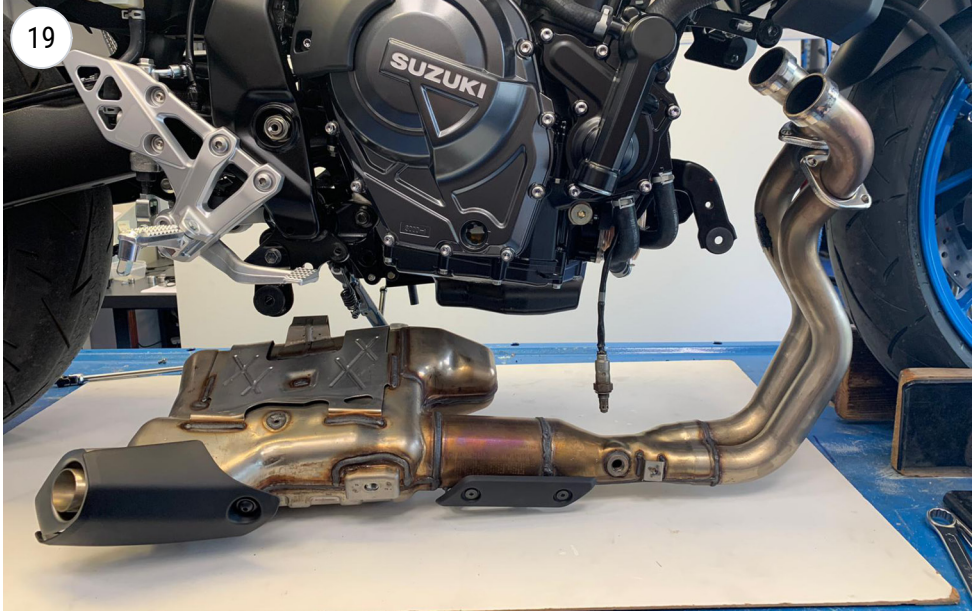

REMOVE THE WHOLE STOCK EXHAUST SYSTEM



UNSCREW

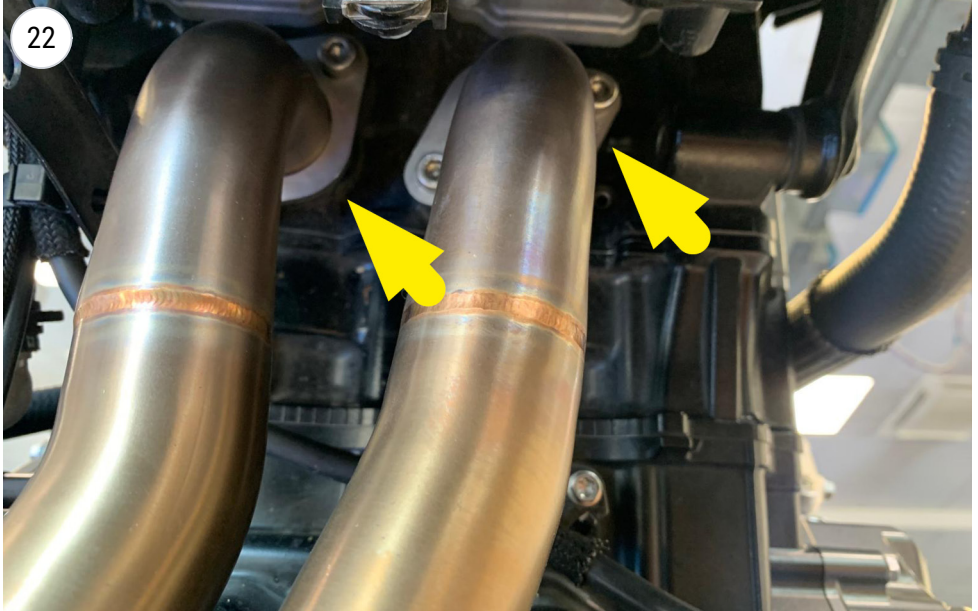

INSTALL THE PRIMARY PIPES

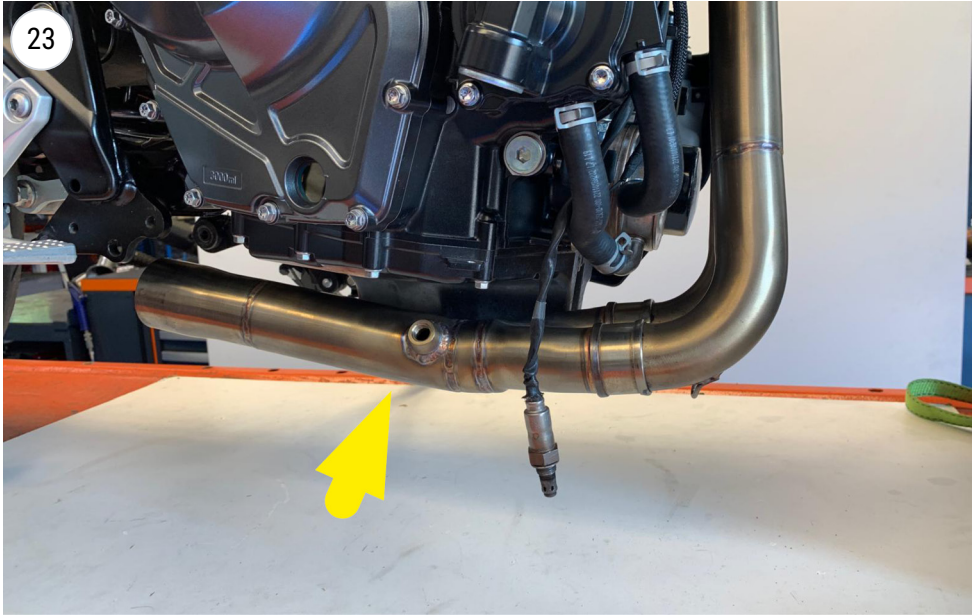

INSTALL THE SECONDARY PIPE



INSTALL THE FINAL PIPE

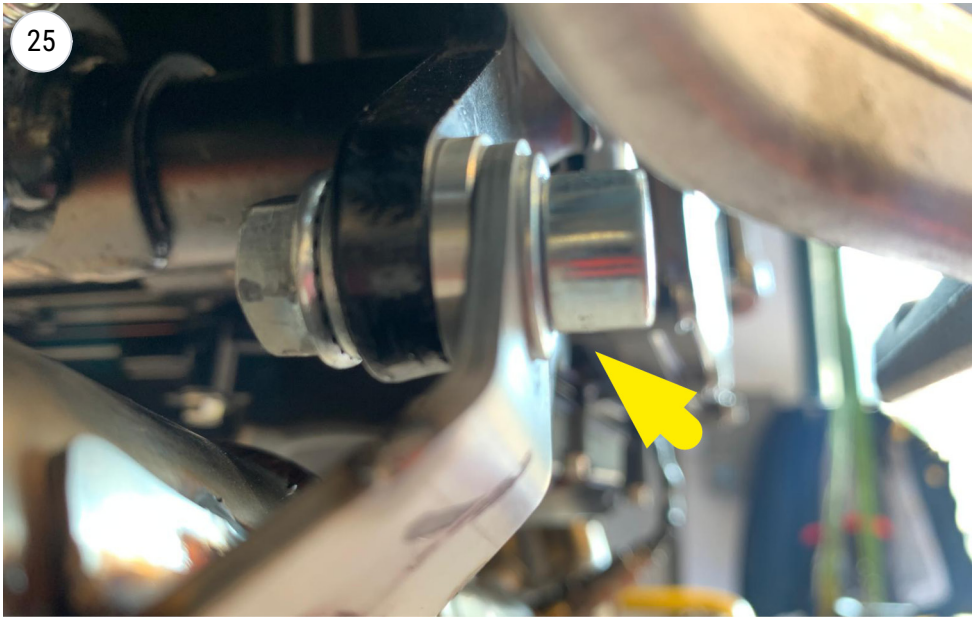

SCREW STACKING



REMOVE THE BRAKE OIL PAN - ONLY IF YOU HAVE THE OPTIONAL 80050 KIT, OTHERWISE GO ON PHOTO 32

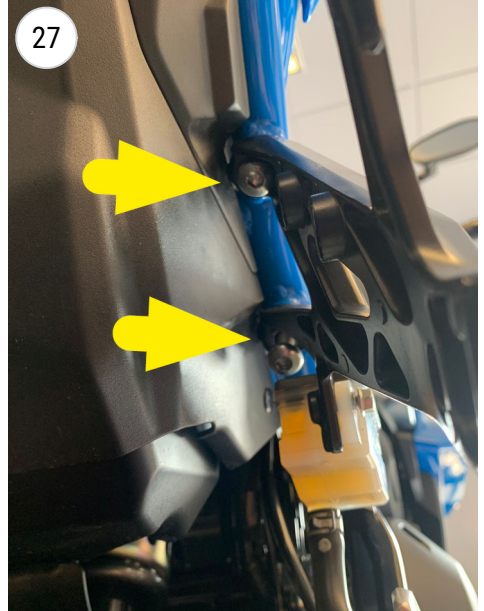

UNSCREW



28

REMOVE THE STOCK PASSENGER FOOTPEG



29

FIT THE LEOVINCE BRACKET AND FIT THE BRAKE OIL PAN

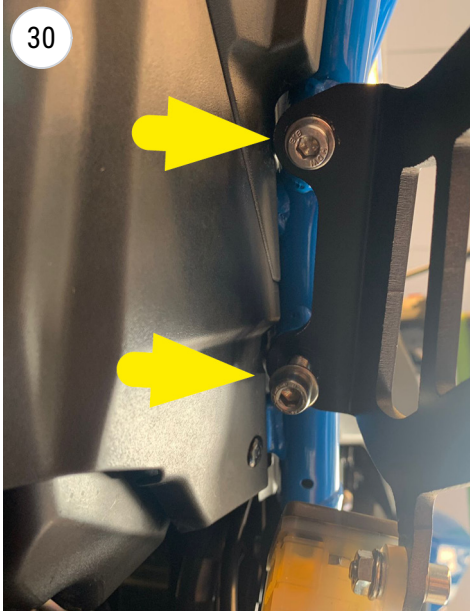

30

SCREW

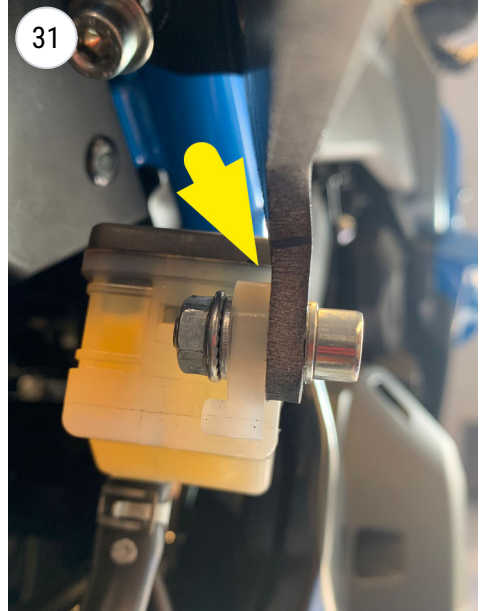

31

SCREW STACKING



32

INSTALL THE BRACKET - IF YOU HAVE THE 80050 KIT GO ON PHOTO 33

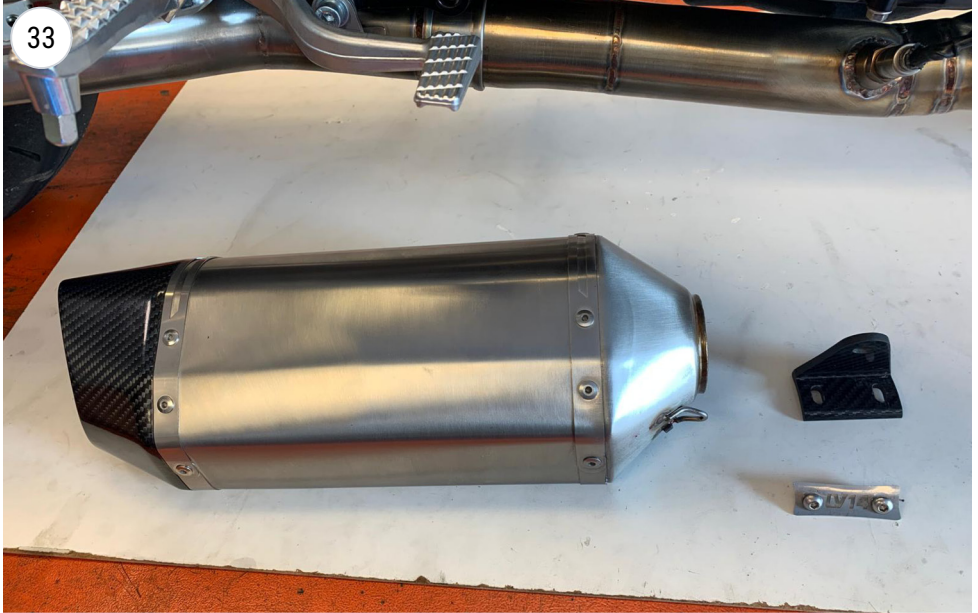

33

FIT THE BRACKET ON THE MUFFLER

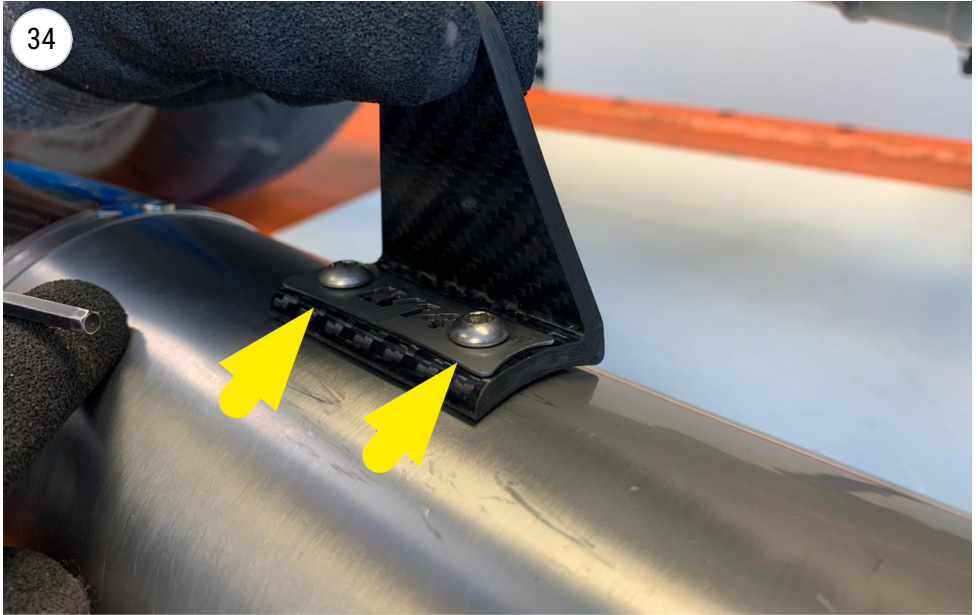

FIT THE BRACKET WITH THE LOOSE SCREWS



INSTALL THE MUFFLER - ONLY IF YOU HAVE THE OPTIONAL 80050 KIT
OTHERWISE GO ON PHOTO 38

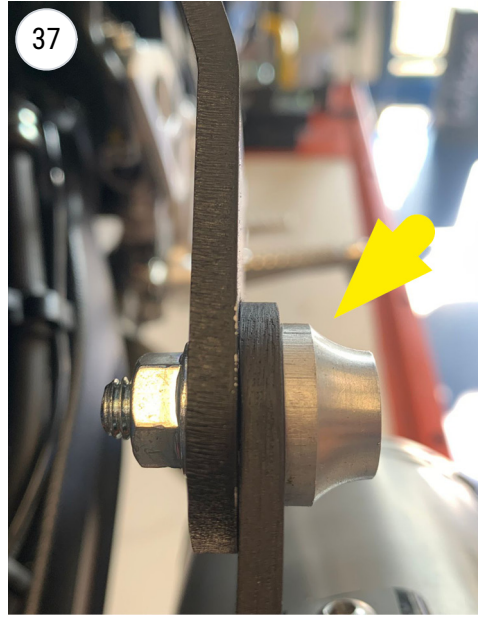

SCREW STACKING



INSTALL THE MUFFLER - IF YOU HAVE THE OPTIONAL 80050 KIT GO ON PHOTO

39

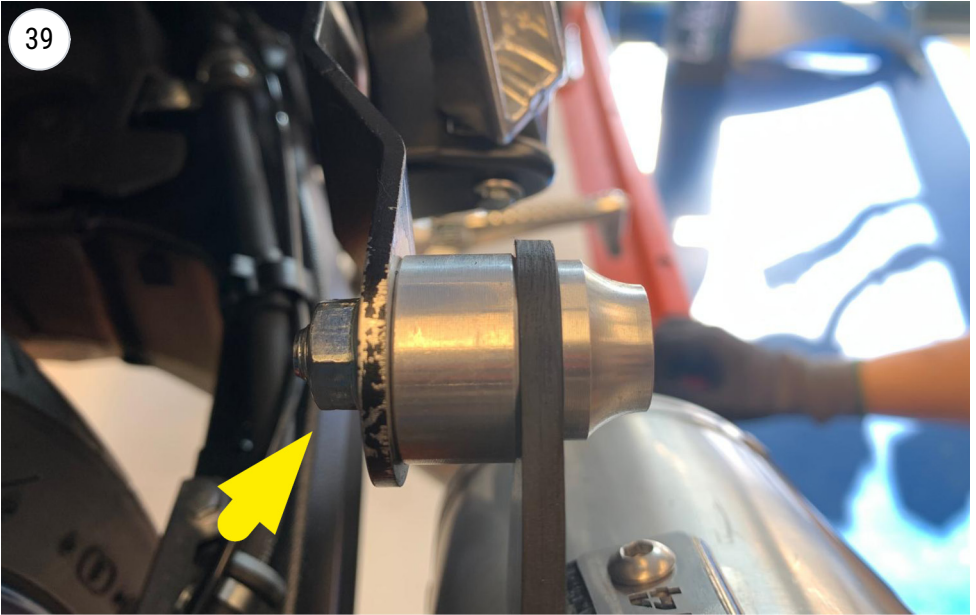

SCREW STACKING

40



CHECK THE POSITION OF THE MUFFLER



TIGHT THE SCREW



INSTALL THE CARBON HEAT SHIELD

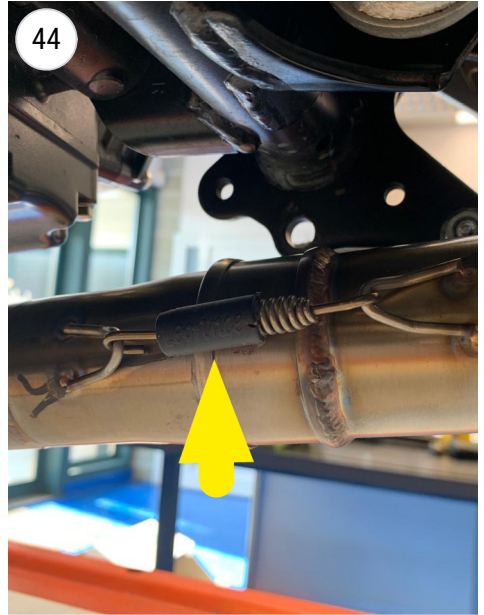
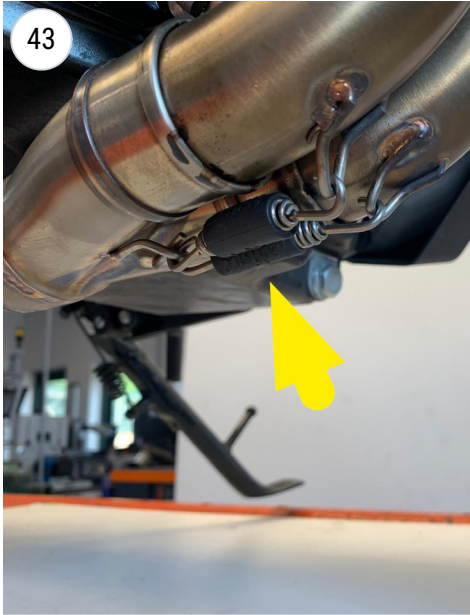

HANG THE SPRINGS



HANG THE SPRING

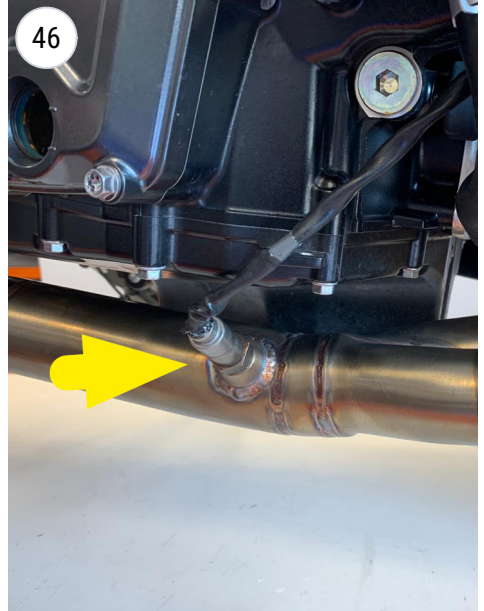

INSTALL THE LAMBDA/OXYGEN
SENSOR

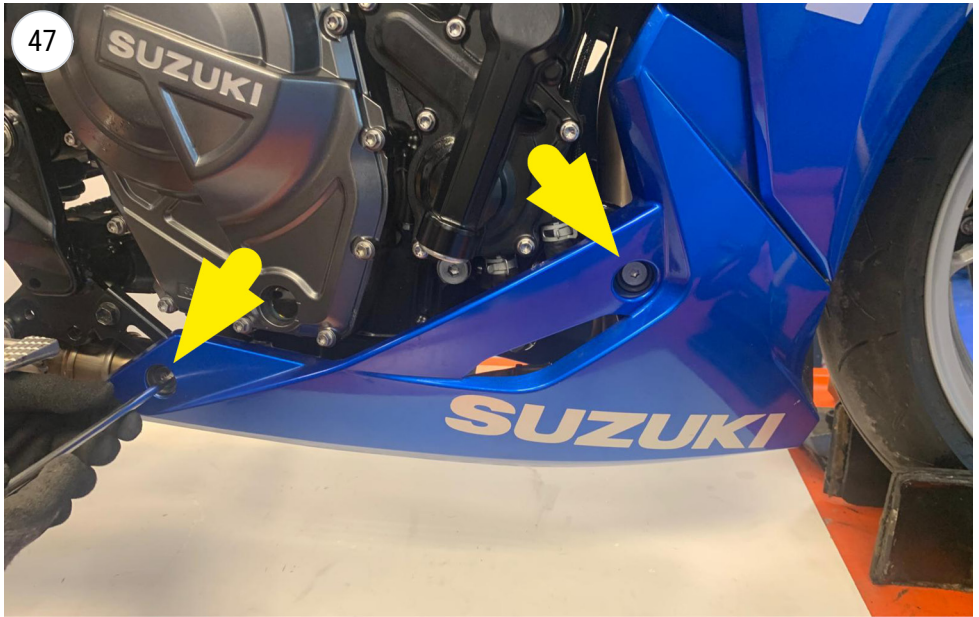

47
SCREW - ONLY IF YOU HAVE SUZUKI GSX-8R, OTHERWISE YOU CAN REINSTALL ALL THE NECESSARY ORIGINAL COMPONENTS

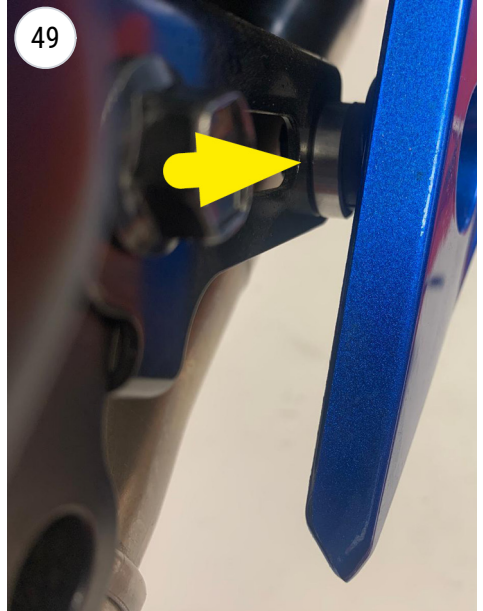

48
49
SCREW STACKING

LISTA DEI COMPONENTI FORNITI:

Fare riferimento alla distinta componenti ed al disegno del prodotto presenti in questo libretto.

ATTENZIONE:

Prima di effettuare qualsiasi operazione accertarsi che la temperatura superficiale del blocco motore e dell'impianto di scarico sia tale da non procurare danni all'operatore e/o alle parti non resistenti al calore (carene, tubazioni, guaine, ecc.).

INSTALLAZIONE:

 **Se necessario, battere i tubi di collegamento con un martello di gomma per innestarli correttamente.**

 **É consigliato personale specializzato per l'installazione.**

Foto di riferimento [[da - a]]

01. Rimuovere la carenatura. [[01 - 12]]

02. Scollegare la/le sonda/e Lambda. [[14]]

03. Smontare tutto l'impianto di scarico originale. [[15 - 21]]

04. Verificare che tutte le superfici di accoppiamento siano pulite ed in buone condizioni.

05. Calzare i collettori primari, verificare il loro corretto orientamento e fissarli alle flange con le molle in dotazione. [[22]]

06. Collegare il/i collettore/i LeoVince al/i collettore/i precedente/i. [[23]]

07. Collegare il/i collettore/i finale/i nel/i precedente/i. [[24 - 25]]

08. Rimuovere la pedana passeggero con tutto il suo supporto. [[26 - 28]]

09. Fissare la/e staffa/e al telaio. [[28 - 30]]

10. Fissare la/e staffa/e al telaio. [[32]]

11. Avvitare la staffa in carbonio con relativa piastrina senza stringere completamente le viti per permettere possibili aggiustamenti. [[33 - 34]]

12. Installare il/i silenziatore/i LeoVince. [[35 - 41]]

13. Installare il/i carter paracalore. [[42]]

14. Vincolare le parti con la/e molla/e o fascetta/e in dotazione. [[43 - 45]]

15. Collegare la/e sonda/e Lambda (e/o il tappo) all'impianto di scarico. [[45]]

16. Montare distanziali, rondelle e staffe di supporto (quando presenti), e serrare il tutto con la bulloneria, se in dotazione, oppure originaria (come indicato a disegno). [[47 - 49]]

17. Reinstallare le parti necessarie, precedentemente rimosse, procedendo in senso inverso.

18. Verificare il corretto allineamento di tutti i componenti, verificare tutti i serraggi ed infine avviare il motore, attendere alcuni minuti che venga raggiunta la temperatura di funzionamento e verificare che non vi siano fughe di gas.

NOTA BENE:

Durante i primi km di utilizzo l'impianto di scarico, subirà degli assestamenti ed è possibile che si verifichino minime fughe di gas. Dopo una percorrenza di circa 100 km è necessario effettuare un controllo del serraggio di tutta la bulloneria.

È normale che del fumo bianco fuoriesca dallo scarico dopo il primo utilizzo, anche dopo lo spegnimento il motore.

REGOLAZIONE:

La messa a punto di questo silenziatore è stata effettuata nello stabilimento LeoVince su banco di prova elettronico con un veicolo in perfetto stato di utilizzo e regolazioni standard.

MANUTENZIONE:

Verificare periodicamente gli attacchi del silenziatore e tutti gli elementi che possono deteriorarsi con l'uso (materiale fonoassorbente, guarnizioni e altre parti in gomma) e provvedere alla loro periodica sostituzione. Per la pulizia del silenziatore è possibile utilizzare benzina, gasolio ed alcool, prestando attenzione ad agire in totale sicurezza e proteggendo le parti del corpo che potrebbero venire a contatto con gli agenti aggressivi, in particolar modo occhi e mani. Non devono essere usati solventi in alcun caso. Un eventuale cambiamento del colore del silenziatore è dato da un utilizzo normale e dipende dalla natura dei materiali e dal calore.

È VIETATA OGNI MODIFICA O MANOMISSIONE del silenziatore di scarico.

BELGROVE SP. Z O.O. DECLINA OGNI RESPONSABILITÀ derivante da vizi, difetti e cattivo funzionamento del prodotto manomesso o modificato.

LIST OF SUPPLIED PARTS:

Refer to the list of components and the product drawing included in this booklet.

WARNING:

Before carrying out any work on the exhaust, check that its surface has cooled so that it will not damage components, which are not heat-resistant (such as fairing, hoses, rubber sleeves, etc.), or the operator.

INSTALLATION:

 **If necessary, use a rubber mallet to tap the connection pipes into place.**

 **We suggest the fitting to be made by professionals.**

Reference pictures [[from - to]]

01. Remove the fairing. [[01 - 12]]

02. Disconnect the Lambda sensor/s. [[14]]

03. Remove the entire original exhaust system. [[15 - 21]]

04. Check that all mating surfaces are clean and in good conditions.

05. Fit the primary manifolds, check their orientation is correct and then secure them to the flanges with the supplied springs. [[22]]

06. Connect the LeoVince pipe to the last previous pipe/s. [[23]]

07. Connect the final pipe/s to the last previous one/s. [[24 - 25]]

08. Remove the passenger's footpeg with its support. [[26 - 28]]

09. Install the bracket/s to the frame. [[28 - 30]]

10. Install the bracket/s to the frame. [[32]]

11. Screw on the carbon bracket with its plate without fully tightening the screws to allow for possible adjustments. [[33 - 34]]

12. Install the LeoVince muffler/s. [[35 - 41]]

13. Install the heat shield/s. [[42]]

14. Link the parts together with the supplied spring/s or clamp/s. [[43 - 45]]

15. Connect the Lambda sensor (and/or plug/s in case) to the pipe/s. [[45]]

16. Mount spacers, washers and brackets (if any) as shown on the drawing and then secure by tightening nuts and bolts, if provided, or stock (shown on drawing). [[47 - 49]]

17. Reinstall all the necessary original components, previously uninstalled, proceeding in reverse.
18. Check for correct alignment of all components, check all tightenings and finally start the engine, wait a few minutes for the operating temperature to be reached and check for gas leaks.

IMPORTANT:

During the first km of running, the exhaust system needs breaking-in; therefore, slight gas leakage might occur. After approximately 100 Km, check all the fasteners.

It is normal for some white smoke to appear the first time you use the exhaust, even after switching off the engine.

ADJUSTEMENT:

This silencer has been developed by LeoVince on an electronic dynamometer using a vehicle in perfect condition, and in standard trim.

MAINTENANCE:

From time to time, check all the brackets and fasteners, which could be affected by use (sound-deadening material, seals and other rubber parts) and replace them periodically. The silencer may be cleaned using gasoline, diesel oil or alcohol. Absolutely avoid the use of any kind of solvent. It is normal for there to be some discolouration of the silencer, which is the result of heat and the nature of the materials used.

IT IS FORBIDDEN TO MODIFY SILENCERS. Whatever form this may take, Belgrove Sp. z o.o. declines any responsibility for defects, problems, or malfunction, arising from the use of any product which has been modified or tampered with.

BELGROVE SP. Z O.O. DECLINES ANY RESPONSIBILITY for defects, problems, or malfunction, arising from the use of any product which has been modified or tampered with.

LISTE DES PIÈCES FOURNIES:

Se référer à la liste des pièces et au croquis du produit inclus dans cette notice.

ATTENTION:

Avant d'effectuer toute opération, vérifier que le pot d'échappement est bien froid afin d'éviter toute brûlure et toute détérioration aux pièces (carénage, tubes, gaines, etc.).

MONTAGE:

 **Si nécessaire, utilisez un maillet en caoutchouc pour taper sur les tubes afin de les emboîter correctement.**

 **Nous conseillons d'effectuer le montage à l'aide personnel spécialisée.**

Photos de référence [[de - à]]

01. Déposer le sabot. [[01 - 12]]

02. Débrancher la/les sonde/s Lambda. [[14]]

03. Démonter tout l'échappement d'origine. [[15 - 21]]

04. Vérifier le nettoyage et le bon état des parties à emboîter.

05. Emboîter ensuite les collecteurs primaires, vérifier leur orientation et les fixer sur les brides à l'aide des ressorts fournis. [[22]]

06. Connecter le/s collecteur LeoVince, dan/s le/s tube/s de raccord precedent. [[23]]

07. Connecter le/les collecteur/s final dan/s le/s collecteur/s precedent. [[24 - 25]]

08. Retirer le repose-pied du passager avec tout son support. [[26 - 28]]

09. Fixer la/les patte/s au cadre. [[28 - 30]]

10. Fixer la/les patte/s au cadre. [[32]]

11. Visser le support en carbone avec sa plaque sans serrer complètement les vis pour permettre d'éventuels ajustements. [[33 - 34]]

12. Fixer le/s silencieux LeoVince. [[35 - 41]]

13. Fixer le/s cache pare-chaleur. [[42]]

14. Fixer à l'aide des ressort/s ou collier/s fournis. [[43 - 45]]

15. Raccorder la/les sonde/s (et/ou le/s bouchon sonde Lambda) à l'équipement d'échappement. [[45]]

16. Monter les entretoises, les rondelles et les étriers de support, et serrer donc tout l'ensemble par la boulonnerie, si fournie, ou originel (selon le dessin). [[47 - 49]]

17. RéFixer toutes les pièces d'origine nécessaires, précédemment désinstallé, en sens inverse.

18. Vérifier l'alignement correct de tous les composants, contrôler tous les serrages et enfin démarrer le moteur, attendre quelques minutes que la température de fonctionnement soit atteinte et vérifier qu'il n'y a pas de fuites de gaz.

IMPORTANT:

Pendant les premiers km d'utilisation, l'échappement se positionnera. Il est possible qu'il y ait de légères fuites de gaz. Un contrôle du serrage de tous les boulons doit être fait après 100 km.

Il est normal qu'une certaine fumée blanche apparaisse la première fois que vous utilisez l'échappement, même après avoir coupé le moteur.

REGLAGE:

La mise au point de ce silencieux est faite dans l'usine LeoVince sur un banc d'essai électronique avec un véhicule en parfait état de marche et des réglages standards.

ENTRETIEN:

Vérifier périodiquement les fixations du silencieux et tous les éléments susceptibles de s'abîmer avec le temps (matériau de fonoabsorption, joint et autres pièces en caoutchouc) et les remplacer périodiquement. Pour le nettoyage du silencieux, on peut utiliser de l'essence, du gazole ou de l'alcool. Absolument éviter tout type de solvable solvant. Un éventuel changement de couleur du silencieux est dû à une utilisation normale et provient de la nature des matériaux et de la chaleur.

IL EST ABSOLUMENT INTERDIT DE MODIFIER LE SILENCIEUX D'ÉCHAPPEMENT.

Dans le cas contraire, **BELGROVE SP. Z O.O. DÉCLINE TOUTE RESPONSABILITÉ.**



LISTA DE COMPONENTES SUMINISTRADOS:

Comprobar la lista de componentes con el dibujo del producto presente en este manual.

PRECAUCIONES:

Antes de efectuar cualquier operación, hay que asegurarse de que la temperatura superficial del silenciador del escape no pueda causar daños al operario y/o a las piezas que no resisten el calor (carenas, tuberías, vainas etc.).

MONTAJE:

-  **Si es necesario, utilizar un mazo de goma para golpear los tubos de conexión hasta que encajen en su sitio.**
-  **Recomendamos que el montaje se realice con la ayuda de un especialista.**

Imágenes de referencia [[de - a]]

01. Quitar la quilla. [[01 - 12]]
02. Desconectar la/s sonda/s Lambda. [[14]]
03. Desmontar todo el escape original. [[15 - 21]]
04. Verificar la limpieza y el buen estado de las superficies de acoplamiento.
05. Calzar luego los colectores primarios, comprobar su correcta orientación y fijarlos a las bridas con los muelles en dotación. [[22]]
06. Conectar el/los colector/es LeoVince en el/los colector/es que lo precede/n. [[23]]
07. Conectar el/los colector/es final en el/los colector/es que lo precede/n. [[24 - 25]]
08. Quitar el estribo del pasajero con todo su soporte. [[26 - 28]]
09. Fijar el/los soporte/s al chasis. [[28 - 30]]
10. Fijar el/los soporte/s al chasis. [[32]]
11. Atornillar el soporte de carbono con su placa sin apretar del todo los tornillos para permitir posibles ajustes. [[33 - 34]]
12. Instalar el/los silenciador LeoVince. [[35 - 41]]
13. Instalar el/los protector/es de calor. [[42]]
14. Conectar las partes con el/los muelle/s si están en dotación. [[43 - 45]]
15. Conectar la/s sonde/as Lambda al escape, atornillando la unión. [[45]]

16. Montar los separadores, las arandelas y los estribos de soporte y apretar todo con los bulones en dotacion o original, cuando están presentes y tal como se indica en el diseño . [[47 - 49]]
17. Montar todas las piezas de primer equipo necesarias, previamente desinstaladas, en sentido inverso.
18. Compruebe la correcta alineación de todos los componentes, compruebe todos los aprietes y, por último, arranque el motor, espere unos minutos a que alcance la temperatura de funcionamiento y compruebe si hay fugas de gas.

ADVERTENCIA:

Durante los primeros Km. de empleo, el silenciador del escape sufrirá unos asentamientos y es posible que se comprueben mínimos escapes de gas. Después de un recorrido de aproximadamente 100 km. es necesario efectuar un control del apretado de todos los tornillos. Es normal que aparezca algo de humo blanco la primera vez que se utiliza el escape, incluso después de apagar el motor.

REGLAJE:

La puesta a punto de este silenciador ha sido efectuada en la Fabrica LeoVince sobre un banco de pruebas electrónico, con un vehículo en perfecto estado de uso y regulaciones standard.

MANTENIMIENTO:

Verificar periódicamente las uniones del silenciador y todos los elementos que puedan deteriorarse con el uso (material fonoabsorbente, guarniciones y otras piezas en goma) y sustituirlas periódicamente. Para la limpieza del silenciador se puede utilizar gasolina, gasóleo y alcohol. No se puede utilizar solventes de ningún tipo. Un eventual cambio del color del silenciador es normal con el uso y depende de la naturaleza de los materiales y del calor.

ESTÁ TERMINANTEMENTE PROHIBIDA CUALQUIER MODIFICACIÓN Y/O MANIPULACIÓN DEL SILENCIADOR DE ESCAPE.

En caso de realizarse **BELGROVE SP. Z O.O. DECLINA CUALQUIER RESPONSABILIDAD** que pueda derivar de vicios, defectos y mal funcionamiento del producto manipulado y/o modificado.

BESTANDTEILE-LISTE:

Maßgeblich ist die in diesem Heft enthaltene Komponentenliste und die Zeichnung des Produktes.

VORSICHTSMASSNAHMEN:

Bitte vergewissern Sie sich vor jeder Benutzung, daß die Oberflächentemperatur der Auspuffanlage keine Gefahr für den Benutzer bzw. für die nicht hitzebeständigen Teile (Verkleidungen, Leitungen, Ummantelungen usw.) darstellt.

MONTAGE:

 **Klopfen sie die verbindungsrohre gegebenenfalls mit einem gummihammer in die richtige position.**

 **Wir empfehlen, dass die montage mit der hilfe von spezialisten durchgeführt wird.**

Referenzbilder [[von - bis]]

01. Entfernen Sie die Verkleidung/en. [[01 - 12]]

02. Die Lambda-Sonde/n abmontieren. [[14]]

03. Die komplette Original-Auspuffanlage abmontieren. [[15 - 21]]

04. Überprüfung des einwandfreien sauberen in gutem Zustandes der Verbindungsflächen.

05. Die Primär-Auspuffkrümmer montieren, auf richtige Ausrichtung prüfen und durch die beigefügten Federn an den Flanschen befestigen. [[22]]

06. Schiebe den/die LeoVince Verbindungsrohr auf das/die vorherige/n Verbindungsrohr/e. [[23]]

07. Schiebe das/die finale/n Verbindungsrohr/e auf das/die vorherige/n Verbindungsrohr/e. [[24 - 25]]

08. Entfernen Sie die Soziusfußraste komplett. [[26 - 28]]

09. Montieren Sie die/den Halterung/en an das Fahrzeug. [[28 - 30]]

10. Montieren Sie die/den Halterung/en an das Fahrzeug. [[32]]

11. Schrauben Sie die Carbonhalterung mit ihrer Platte an, ohne die Schrauben vollständig anzuziehen, um eventuelle Anpassungen zu ermöglichen. [[33 - 34]]

12. Den/die LeoVince Schalldämpfer befestigen. [[35 - 41]]

13. Das/die Hitzeschild/er befestigen. [[42]]

14. Befestigen Sie die Teile mit der/den Feder/n oder Klammer/n, falls vorhanden. [[43 - 45]]

15. Die Lambda-Sonde/n (und/oder die Lambda Schraube/n) an der dafür vorgesehenen Position an die LeoVince Auspuffanlage anschließen. [[45]]

16. Montieren Sie den/die Abstandhalter, die Unterlegscheiben und den/die Halter (falls vorhanden). Befestigen Sie alles mit den mitgelieferten oder Original Schrauben (siehe Zeichnung). [[47 - 49]]

17. Bauen Sie alle erforderlichen Originalteile, die zuvor entfernt wurden, in umgekehrter Reihenfolge wieder an.

18. Prüfen Sie die korrekte Ausrichtung aller Komponenten und ob alle Schrauben ausreichend festgezogen sind. Starten Sie anschließend den Motor, warten Sie einige Minuten bis die Betriebstemperatur erreicht ist und stellen Sie sicher, dass nirgendwo Abgase austreten.

ZUR BEACHTUNG:

Während der ersten gefahrenen km fährt sich die gesamte Auspuffanlage ein und es ist möglich, daß sich minimale Gasaustritte bemerkbar machen. Nach etwa 100 km Fahrt müssen alle Schrauben überprüft werden und ggf nachgezogen werden.

Es ist normal, dass nach der ersten Benutzung weißer Rauch aus dem Auspuff kommt, auch wenn der Motor abgestellt wurde.

EINSTELLUNG:

Die Vergasereinstellung bei der Montage dieses Schalldämpfers wurde im LeoVince-Werk auf einem elektronischen Prüfstand mit einem Fahrzeug in perfektem Benutzungszustand und mit der vom Werk vorgesehenen Regulierung vorgenommen.

WARTUNG:

Bitte überprüfen Sie in regelmäßigen Abständen die Anschlüsse des Schalldämpfers und alle verschleißanfälligen Elemente (Schalldämmungsmaterial, Dichungen u. andere Gummiteile) und die von Zeit zu Zeit austauschen. Zur Reinigung des Schalldämpfers Benzin, Gasöl oder Alkohol benutzen. Keine Lösemittel verwenden. Eine eventuelle Verfärbung des Schalldämpfers kann beim normalen Gebrauch auftreten und ist kein Grund zur Reklamation.

VERBOTEN IST JEGLICHE VERÄNDERUNG BZW. Eingriffe am Auspuff-Schalldämpfer: bei Zuwiderhandlung lehnt Belgrove Sp. z o.o. jegliche Verantwortung infolge von Schäden, Defekten und mangelnder Funktionsfähigkeit des veränderten Produktes ab.

BELGROVE SP. Z O.O. JEGLICHE VERANTWORTUNG infolge von Schäden, Defekten und mangelnder Funktionsfähigkeit des veränderten Produktes ab.

NOTE - NOTES - REMARQUES - ANMERKUNGEN - NOTAS

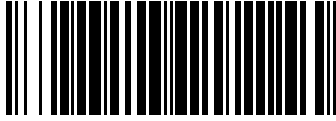

L15606U

2024-12-12 REV.02

LeoVince



leovince.com



International Customer Service:
info@leovince.com

North America Customer Service:
infousa@leovince.com - +1-844-5367625